

RENOGY ONE Vision 7

RSHSN-W02W7-G1

VERSION A0
April 12rd, 2024



USER MANUAL

Before Getting Started

The user manual provides important operation and maintenance instructions for Renogy ONE Vision 7 (hereinafter referred to as ONE Vision).

Failure to observe the instructions or precautions in the user manual can result in electrical shock, serious injury, or death, or can damage the ONE Vision, potentially rendering it inoperable. It is recommended that the ONE Vision should be installed by qualified electrical technicians as electricity knowledge is required.

- Renogy ensures the accuracy, sufficiency, and the applicability of information in the user manual at the time of printing due to continual product improvements that may occur.
- Renogy assumes no responsibility or liability for personal and property losses, whether directly and indirectly, caused by the user's failure to install and use the product in compliance with the user manual.
- Renogy is not responsible or liable for failures, damages, or injuries resulting from repair attempted by unqualified personnel, improper installation, and unsuitable operation.
- The illustrations in the user manual are for demonstration purposes only. Details may appear slightly different depending on product revision and market region.
- Renogy reserves the right to change the information in the user manual without notice. For the latest user manual, visit [renogy.com](https://www.renogy.com).

Disclaimer

Renogy ONE Vision 7 User Manual © 2024 Renogy. All rights reserved.

RENOGY and **RENOGY** are registered trademarks of Renogy.

- All information in the user manual is subject to copyright and other intellectual property rights of Renogy and its licensors. The user manual may not be modified, reproduced, or copied, in whole or in part, without the prior written permissions of Renogy and its licensors.
- The registered trademarks in the user manual are the property of Renogy. The unauthorized use of the trademarks is strictly prohibited.

Table of Contents

1. General Information	1
1.1. Symbols Used	1
1.2. Product Overview	1
1.3. Key Features	1
1.4. Model Info	1
2. Get to Know Renogy ONE Vision 7	2
2.1. What's In the Box?	2
2.2. Product Overview	2
2.3. Wiring Diagram	3
3. Preparation	4
3.1. Recommended Tools & Accessories	4
3.2. Plan an Installation Site	4
3.3. Inspect ONE Vision	6
3.4. Check DC Power	6
4. Installation	6
4.1. Wear Insulating Gloves	6
4.2. Cut an Installation Hole	6
4.3. Install the Mounting Bracket	7
4.4. Install the Power Cable	7
4.5. Network Wiring (Optional)	8
4.6. Secure ONE Vision	8
5. Operation	9
5.1. Power On/Off	9
5.2. Display Dimming	9
6. Networking with Renogy ONE Core	10
6.1. WLAN Networking	10
6.2. Personal Hotspot Networking	11
7. Configuration and Monitoring	13
7.1. My RV	14
7.2. Power Typology	16
7.3. Settings	17
7.4. Alarm & Troubleshooting	18

8. Dimensions & Specifications	19
8.1. Dimensions.....	19
8.2. Technical Specifications.....	20
9. Maintenance	21
9.1. Inspection	21
9.2. Cleaning.....	21
9.3. Storage	21
10. Emergency Responses	22
10.1. Fire.....	22
10.2. Flooding.....	22
10.3. Smell.....	22
10.4. Noise.....	22
11. Important Safety Information	23
11.1. General Safety	23
11.2. ONE Vision Safety.....	23
Renogy Support	24

1. General Information

1.1. Symbols Used

The following symbols are used throughout the user manual to highlight important information.



WARNING: Indicates a potentially hazardous condition that could result in personal injury or death.



CAUTION: Indicates a critical procedure for safe and proper installation and operation.



NOTE: Indicates an important step or tip for optimal performance.

1.2. Product Overview

Renogy ONE Vision is a centralized power management touch panel specially designed for recreational vehicles and campervans. When working in association with Renogy ONE Core and PMS1280 Distribution Box, ONE Vision visualizes power management and control, allowing you easily to control your power supply devices and appliances.

In addition, ONE Vision provides custom scene automation, local troubleshooting solutions, and online troubleshooting support under your permissions, reducing system maintenance costs while enabling a worry-free off-grid journey.

1.3. Key Features

- **High System Reliability**
Works constantly reliably at -4°F to 158°F (-20°C to 70°C).
- **System-wide Power Management**
ONE Vision allows you to control your whole power system by monitoring energy production and consumption and providing real-time alarms and troubleshooting tips. This information is essential for ensuring your power system is operating at its optimal efficiency.
- **Self-Diagnosis with Online Troubleshooting**
ONE Vision integrates local self-diagnosis and online troubleshooting. You can locate easy problems by yourself with the integrated alarms. Alternatively, you can seek for online troubleshooting support to ensure stable device operation.
- **Personal Customization**
ONE Vision allows you to customize system settings, including display language, alarms, and notification preferences, accommodating to personal requirements.
- **Easy to Install**
ONE Vision features a neat design and easy installation. With all included accessories and user manual, you can mount and install ONE Vision in an effort-free manner.

1.4. Model Info

Renogy ONE Vision 7	RSHSN-W02W7-G1
---------------------	----------------

2. Get to Know Renogy ONE Vision 7

2.1. What's In the Box?

Renogy ONE Vision 7 × 1

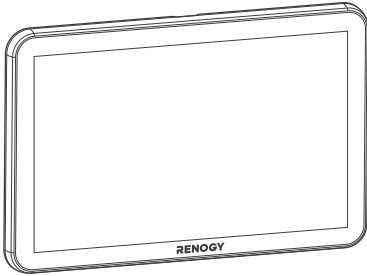

User Manual × 1

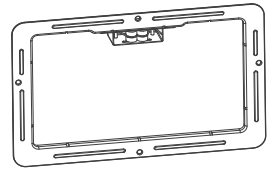

Mounting Bracket × 1

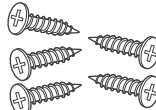

KA3*14 mm

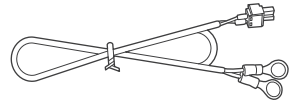

Mounting Screw × 5
(1 Extra)



Power Cable (5 m) × 1

-  Make sure that all accessories are complete and free of any signs of damage.
-  The accessories and product manual listed are crucial for the installation, excluding warranty information and any additional items. Please note that the package contents may vary depending on the specific product model.

2.2. Product Overview

■ Front Side

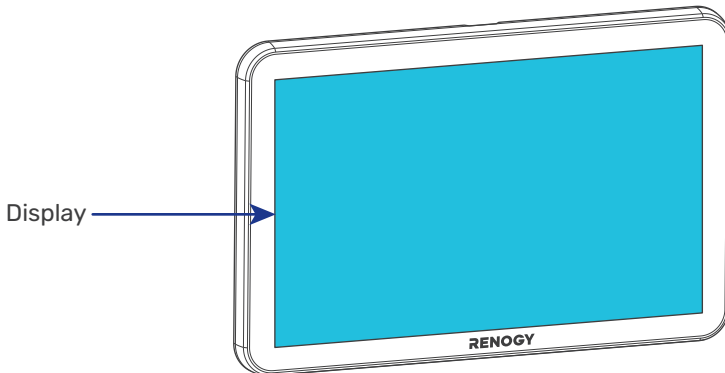

Rear Side

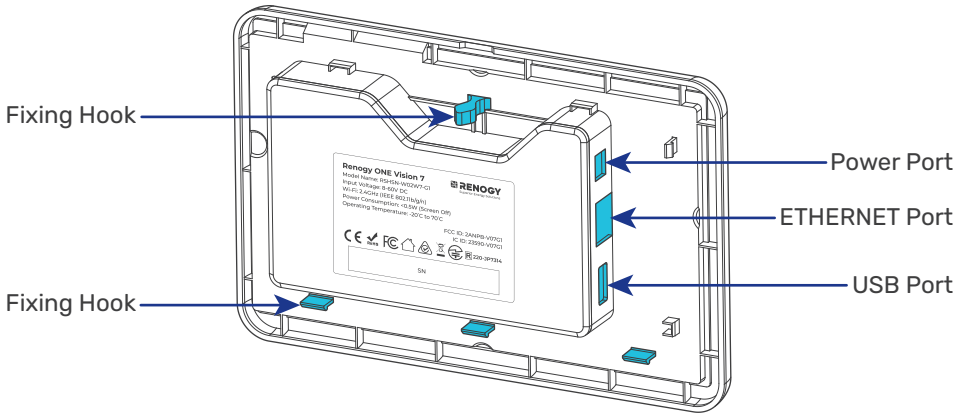

i The USB Port is an internal debugging port reserved for the manufacturer only.

2.3. Wiring Diagram

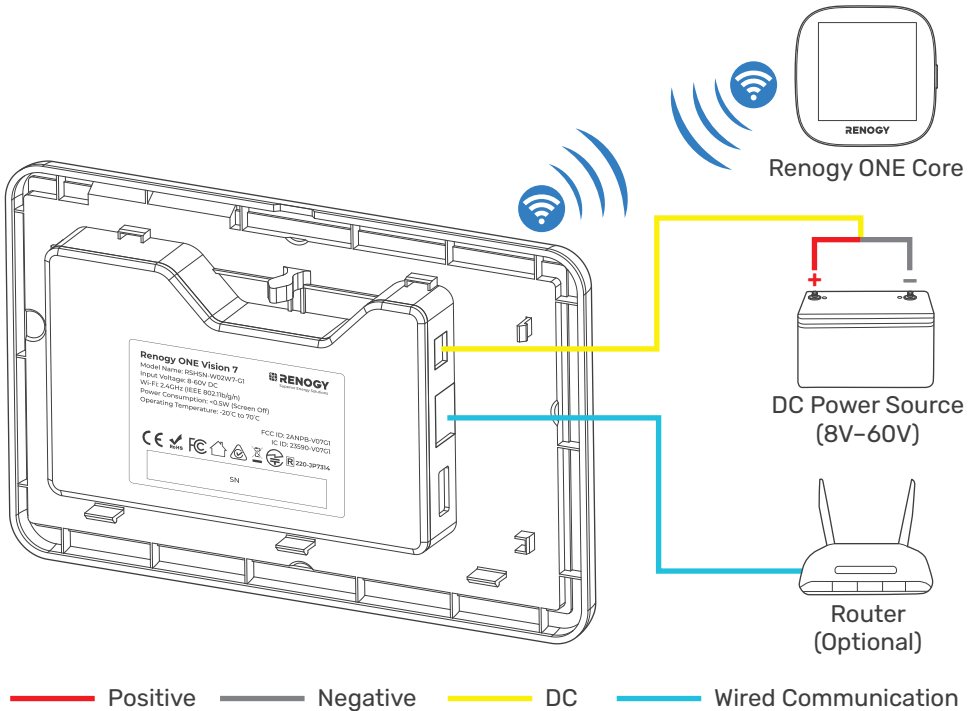

i The ETHERNET Port is optional because Renogy ONE Vision 7 supports WLAN that allows you to connect to a 2.4 GHz Wi-Fi router wirelessly.

3. Preparation

3.1. Recommended Tools & Accessories



Phillips Screwdriver (#1)

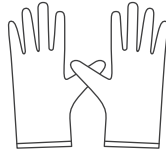

Insulating Gloves

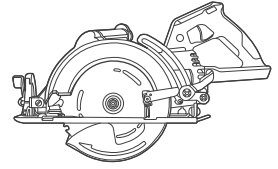

Skill Saw

- i** Prior to installing and configuring ONE Vision, prepare the recommended tools, components, and accessories.
- i** Choose proper mounting screws specific to your installation site. This manual takes wooden walls as an example.

3.2. Plan an Installation Site

The ONE Vision requires adequate clearance for installation, wiring and ventilation. It should be installed on a flat surface indoors protected from direct sunlight.

To ensure quality wireless communication between Renogy ONE Vision and Renogy ONE Core, ensure there is no metal objects near Renogy ONE Vision and keep a maximum distance of 10 m (3.28 ft) between ONE Vision and ONE Core.

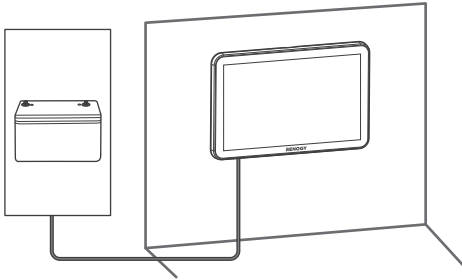

 -20°C to 70°C
-4°F to 158°F

 10% to 90%
RH



In scenarios where the distance between ONE Vision and the DC source is longer than 5 m, extend the included power cable by using extra bare wires.

Recommended Tools & Accessories

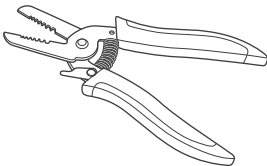

Wire Stripper

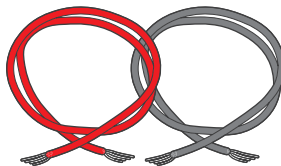

Bare Wires (≥ 22 AWG) x 2

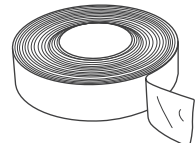

Insulation Tape

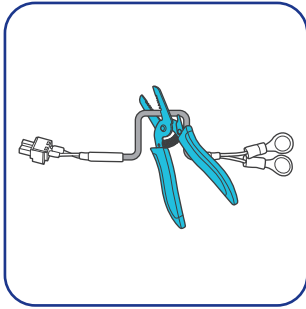

1. Cut the included power cable using a wire stripper.

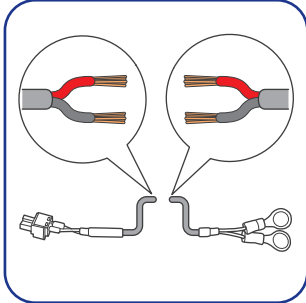

2. Strip off some of the insulation.

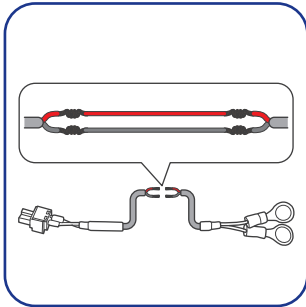

3. Strip some insulation off the bare wires, and connect them to the included power cable by twisting them together.

i Acceptable connection methods include heating tubes, junction boxes, and welding.

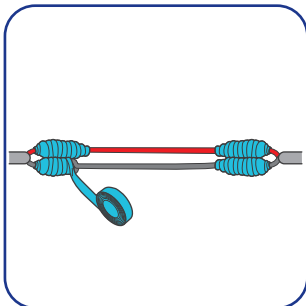

4. Tape over the cutoff areas.

3.3. Inspect ONE Vision

Inspect ONE Vision for any visible damage including cracks, dents, deformation, and other visible abnormalities. All connector contacts shall be clean and dry, free of dirt and corrosion.

 Do not use Renogy ONE Vision if there is any damage.

3.4. Check DC Power

Inspect the DC power source for any visible damage including cracks, dents, deformation, and other visible abnormalities. All connector contacts shall be clean and dry, free of dirt and corrosion.

ONE Vision works normally with an 8V to 60V DC power source. When the DC power source is below 8V, ONE Vision cannot be started. A DC power source rating higher than 60V may damage ONE Vision.

4. Installation

4.1. Wear Insulating Gloves

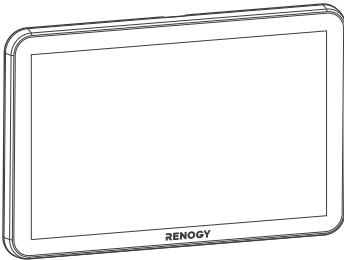

Insulating Gloves —

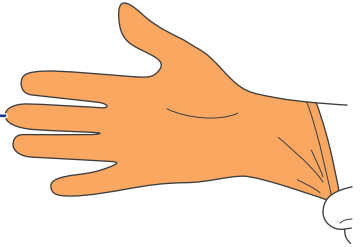

4.2. Cut an Installation Hole

Cut a rectangular installation hole at 6.07 × 3.71 in (154 × 94 mm) on a wall by using a skill saw. The recommended minimum depth for the hole should be 0.79 inches (20 mm).

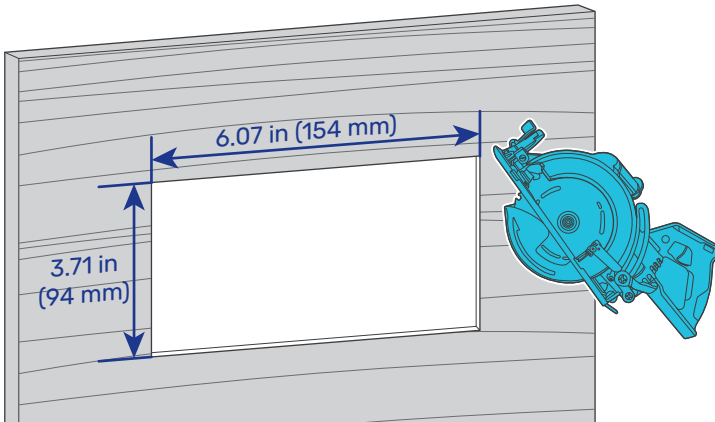

i The recommended minimum depth for the hole should be 0.79 inches (20 mm).

4.3. Install the Mounting Bracket

Step 1: Place the mounting bracket in the installation hole with the bottom facing towards the hole, as shown in the figure below.

Step 2: Secure the mounting bracket with the included mounting screws.

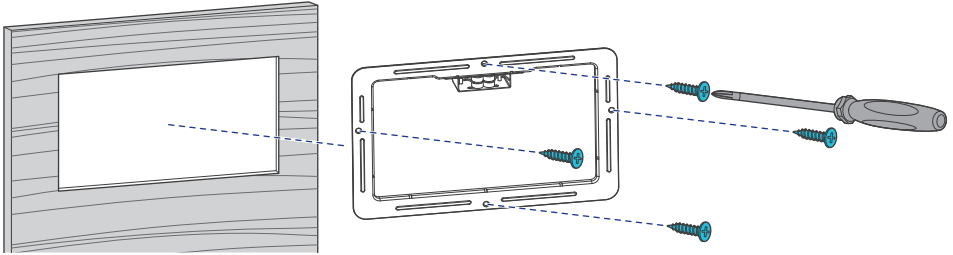

i Please ensure the mounting bracket is firmly secured to the mounting location to prevent from falling off.

4.4. Install the Power Cable

Step 1: Connect the power cable connector to the POWER port on ONE Vision.

Step 2: Verify the polarity of the power cable. Connect the negative ring (black cable) to the negative terminal of a DC power source.

Step 3: Connect the positive ring (red cable) to the positive terminal of the DC power source.

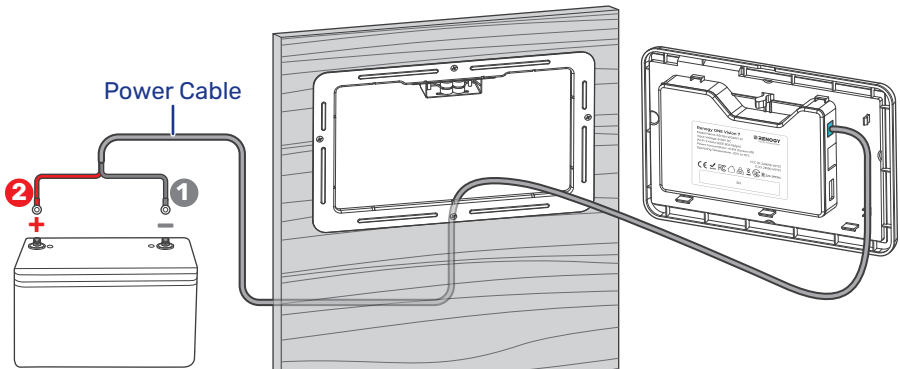

⚠ Always connect the negative end before the positive one when wiring a DC power source.

4.5. Network Wiring (Optional)

The ETHERNET Port is optional because Renogy ONE Vision 7 supports WLAN that allows you to connect to a 2.4 GHz Wi-Fi router wirelessly.

Recommended Tools & Accessories

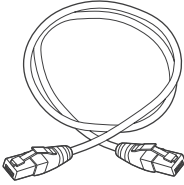

RJ45 Ethernet Cable
(Category 5 and Above)

Connect a RJ45 Ethernet cable from the ETHERNET Port on ONE Vision to a network device (router or switch).

A RJ45 Ethernet cable shall not exceed 19.6 feet (6 m).

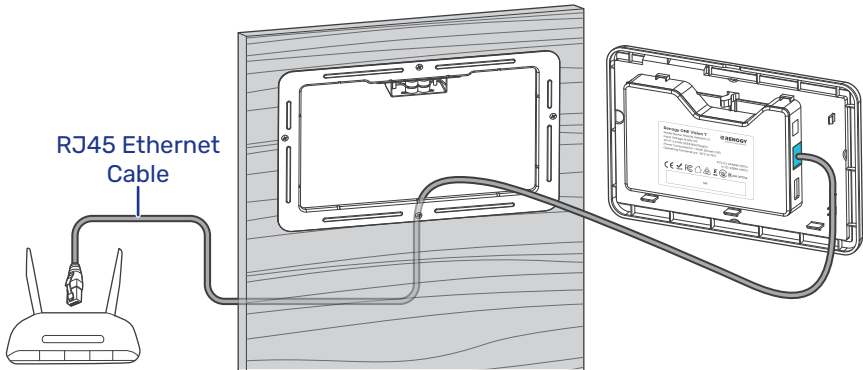

4.6. Secure ONE Vision

Step 1: Verify that all cable connections are firmly and securely fastened. This step is essential to prevent any loose or unstable connections that could lead to operational issues or safety concerns.

Step 2: Align the three fixing hooks beneath the ONE Vision with the bottom of the mounting bracket and insert them into the mounting bracket from the top downward.

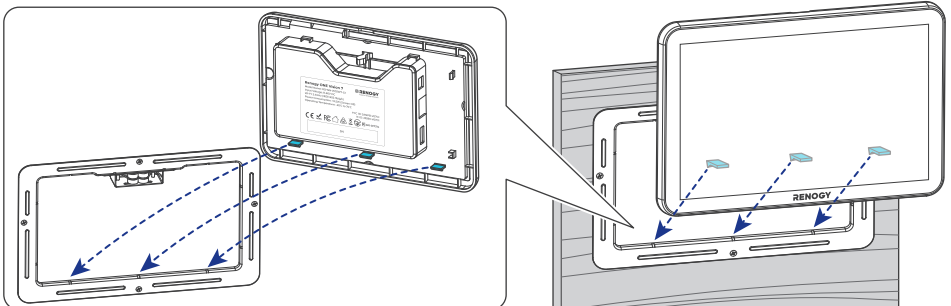

Step 3: Align the upper fixing clips of the ONE Vision with the slots on the upper part of the mounting bracket and insert them vertically

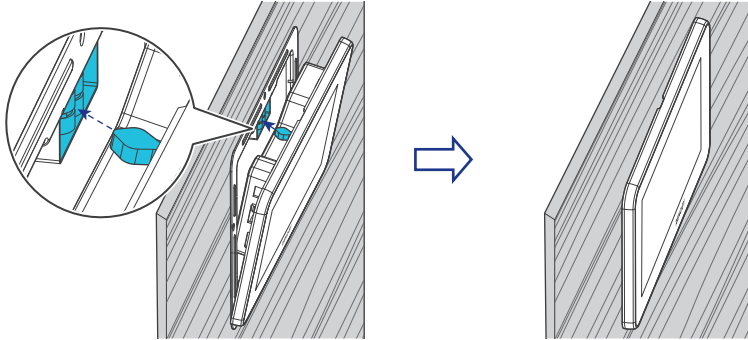

i Please ensure the ONE Vision is firmly secured to the mounting location to prevent from falling off.

5. Operation

5.1. Power On/Off

ONE Vision automatically starts upon power on. To power it off, disconnect the power cable from ONE Vision.

To power on ONE Vision again, connect the power cable to it. ONE Vision automatically synchronizes settings configured prior to powering off, ensuring seamless retention and application of user preferences.

5.2. Display Dimming

The default factory setting for the ONE Vision is "Never" for Dimming. You can modify the setting by tapping "⚙️ > Display". Options include Never, 15s, 30s, 1min, 3min, 5min, 10min, and 30min.

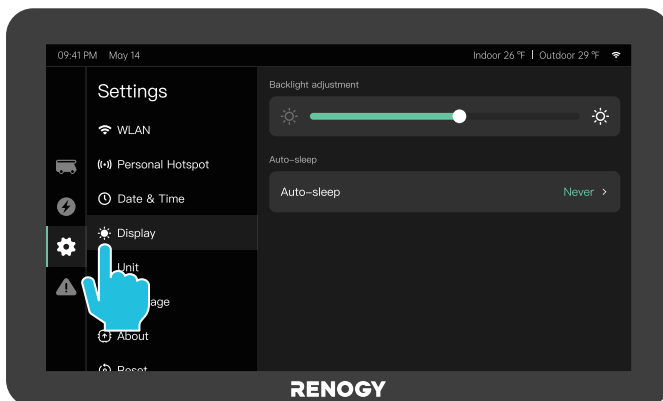

The ONE Vision display dims after a preset period of inactivity. Touch the display to lighten it.

i If ONE Vision display cannot be lightened, check the voltage of the DC power source. Ensure the voltage is no smaller than 8V.

6. Networking with Renogy ONE Core

Both Renogy ONE Vision and Renogy ONE Core are integral part of Renogy ONE Family. To ensure data synchronization on ONE Vision and ONE Core, ONE Vision needs to be paired with ONE Core.

You can pair ONE Vision with ONE Core via either WLAN or personal hotspot .

- i** On ONE Vision, you can enable either WLAN or personal hotspot. Enabling WLAN automatically disables personal hotspot, and vice versa.
- i** The user interface may vary depending on software versions. Refer to the actual interface for accuracy. The illustrations in the user manual are for demonstration purposes only.
- i** For technical support, contact Renogy customer service via renogy.com/contact-us for help.

6.1. WLAN Networking



WLAN networking is applicable to scenarios when there is an available 2.4 GHz Wi-Fi router.

Step 1: Connect ONE Core to an available WLAN.

Step 2: Connect ONE Vision to the same WLAN to which ONE Core has been connected.

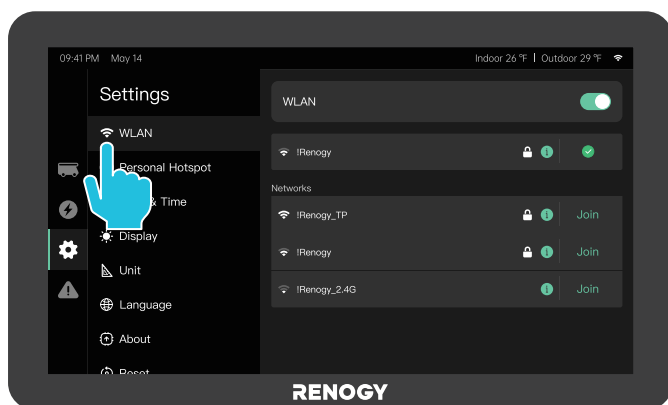
On ONE Vision, tap “  > **WLAN**”. Tap the same WLAN as ONE Core, enter password, and tap **Join**.



Step 3: ONE Vision automatically searches ONE Core in the WLAN and displays ** Connecting to core...** after successful discovery. ONE Vision automatically connect to ONE Core, and the ** Connecting to core...** disappears.

■ How to Ensure ONE Vision and ONE Core Are in the Same WLAN?

On ONE Vision, navigate to “ > **WLAN**”, and tap  on the right side of the connected WLAN. You can check the WLAN information.

Ensure the first three sets of digits in the IP address are the same as those on ONE Core. For example, the first three digits of the IP address in the following figure is 192.168.1.



6.2. Personal Hotspot Networking

Personal hotspot networking is applicable to scenarios when there is no available 2.4 GHz Wi-Fi router. We use either ONE Vision or ONE Core as an access point.

 Both ONE Vision and ONE Core support 2.4 GHz personal hotspot.

■ ONE Vision as an Access Point

Step 1: On ONE Vision, navigate to “ > **Personal Hotspot**”, and enable Personal Hotspot. You can check the “Hotspot Name” and “Hotspot Password” of Renogy ONE Vision.

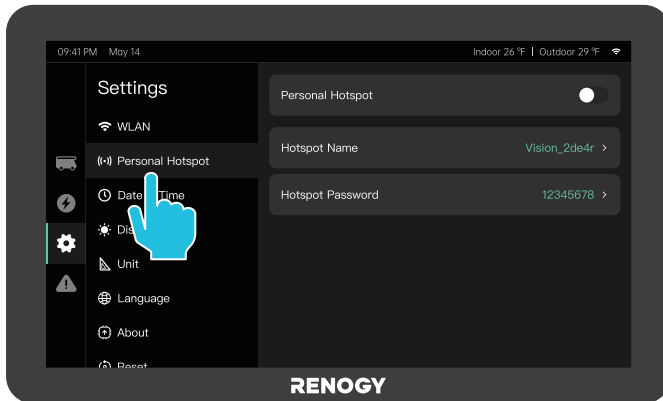

Step 2: On ONE Core, go to “ > **System** > **Network** > **WLAN**”, and choose the WLAN named as Hotspot Name of ONE Vision.

Step 3: Enter “Hotspot Password” of ONE Vision in the “Password” dialogue box, and tap **Join**.

After successful networking, you can see the ONE Vision widget on ONE Core.

■ ONE Core as an Access Point

Only Renogy ONE Core G2 and later generations support the access point function. Check the silkscreen on the rear side of Renogy ONE Core, and ensure there is G2 and higher generation silkscreen in the SKU. For details, contact Renogy customer service team via renogy.com/contact-us.

Step 1: On ONE Core, go to “ > **System > Network > AP**”, and enable AP to obtain the “SSID” and “Password” of Renogy ONE Core.



Step 2: On ONE Vision, go to “ > **WLAN**”, and choose the WLAN named as ONE Core SSID.

Step 3: Enter “Password” of ONE Core in the “Enter a Password” dialogue box, and tap **Join**.



After successful networking, you can see the ONE Vision widget on ONE Core.

7. Configuration and Monitoring

Renogy ONE Vision is available in two modes depending on the target users.

- For dealers or RV manufacturers: ONE Vision is in default Factory Mode. Go to “**> About > Version**”, and tap “Version” 5 times in a row to enter Factory Mode. For detailed instructions and factory password, contact Renogy customer service via renogy.com/contact-us.
- For end users: Renogy ONE Vision is ready for use after power on.

i The user interface may vary depending on software versions. Refer to the actual interface for accuracy. The illustrations in the user manual are for demonstration purposes only.

Both Renogy ONE Vision and Renogy ONE Core are integral part of Renogy ONE Family. Prior to configuring ONE Vision, ensure it is paired with Renogy ONE Core. For instruction details, see “[6. Networking with Renogy ONE Core](#)”.

You can configure and monitor the following information on ONE Vision:

- My RV
- Power Topology
- Settings
- Alarm & Troubleshooting

You can switch to different interfaces in the Menu on the left side of Renogy ONE Vision.

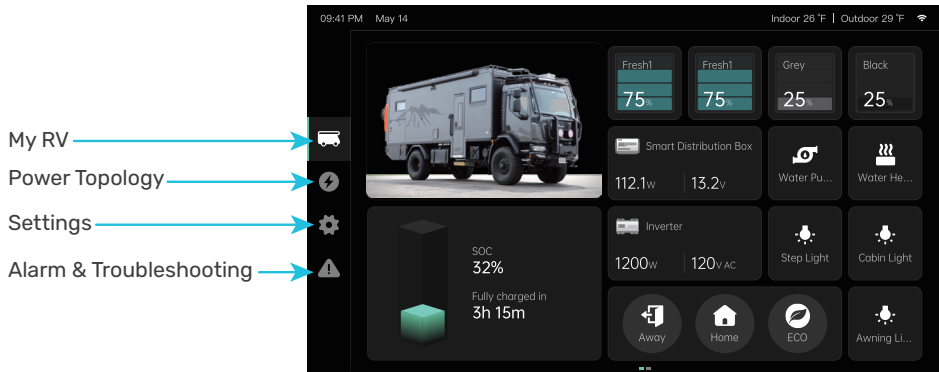

7.1. My RV

By default, ONE Vision displays My RV as the home screen where you can check the basic info of as well as operating status of power devices that are connected to Renogy ONE Vision in your RV.

Every connected device or mechanical switch is displayed as a widget on Renogy ONE Vision. Renogy ONE Vision supports two types of widgets:

- **Display Widget** that displays device info only.
- **Operation Widget** that displays device info and at which you can perform an action.

The following figure is an example of a My RV page, showcasing connected power devices and switches to you RV.

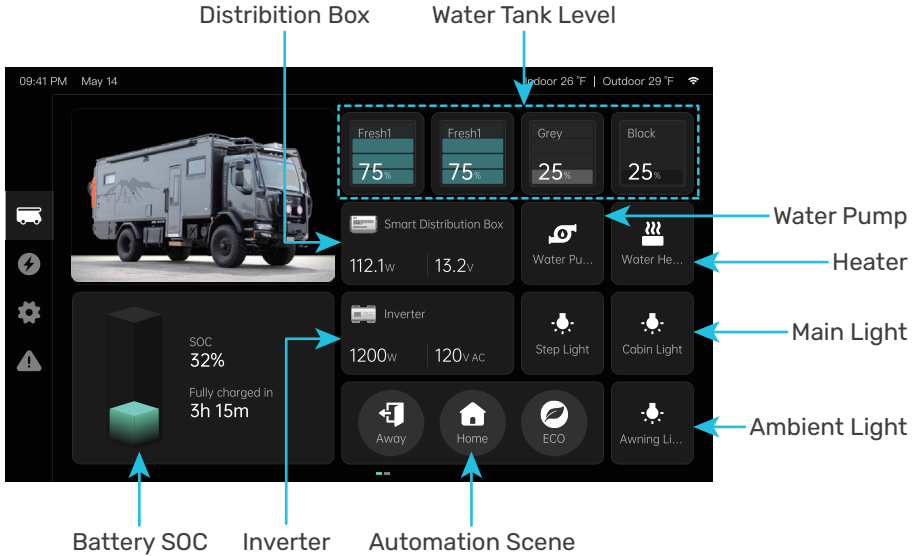

Add a Widget

The My RV interface displays the status of connected devices. When a new device is connected, ONE Vision does not automatically display its widget on the main screen. Users need to manually add it themselves.

Step 1: In the My RV interface, tap and hold a widget to enter Editing Mode. Tap  in the lower-left corner of the interface.

Step 2: In Editing Mode, select a device that you want to add to the interface, and tap .

Step 3: After successful widget addition, tap  in the lower-right corner of the interface.

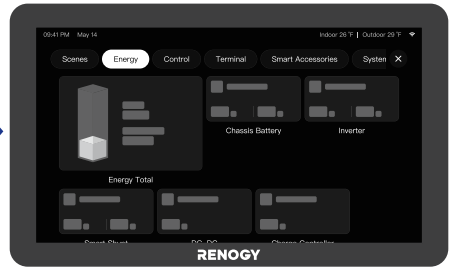

Renogy ONE Vision automatically displays the currently connected devices in a default layout. You can change the layout by tapping and holding the widgets and then dragging them to the required locations. For details, see [Move a Widget](#).

■ Move a Widget

Step 1: In the My RV interface, tap and hold a widget to enter Editing Mode.

Step 2: Tap and hold a widget, and then drag it to the required location.

Step 3: After successfully moving the widget, tap  in the lower-right corner of the interface.

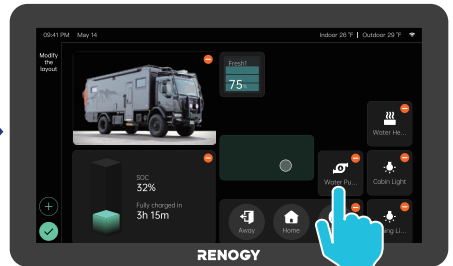

■ Delete a Widget

Step 1: In the My RV interface, tap and hold a widget to enter Editing Mode.

Step 2: Tap  in the upper-right corner of the widget to remove it from the interface.

Step 3: After successfully removing the widget, tap  in the lower-right corner of the interface.

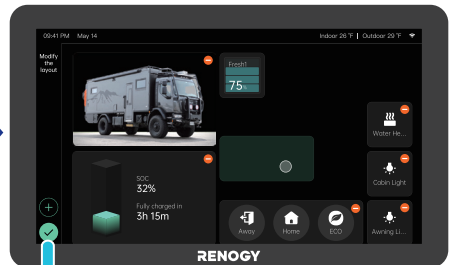
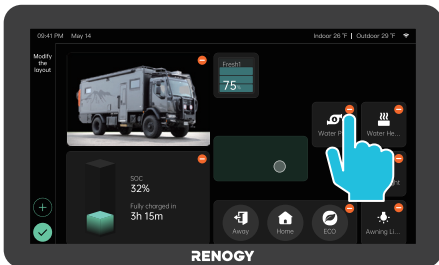

7.2. Power Typology

The Power Typology interface allows you to see the current direction going in or out of power supply devices and appliances that are connected to Renogy ONE Vision, helping you easily obtain the operating status of the devices. Supported devices include:

- Solar Panel
- Controller
- Alternator/Starter Battery
- DC-DC Battery Charger
- Inverter
- Smart Distribution box
- Battery
- AC Input
- AC/DC Load

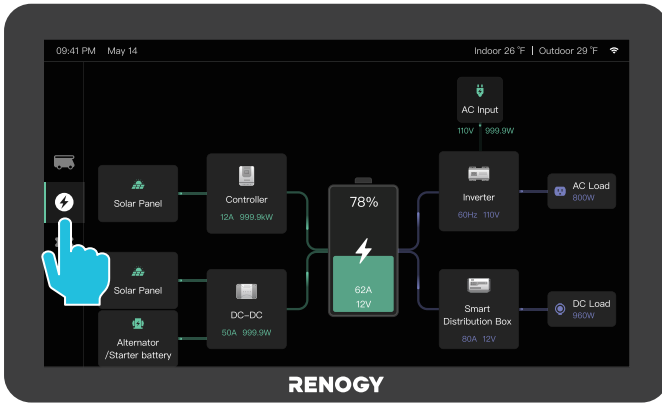

You can tap the device icon (charge controller, DC-DC battery charger, battery, and inverter) to view the device details. The following figures provide an example of a controller.

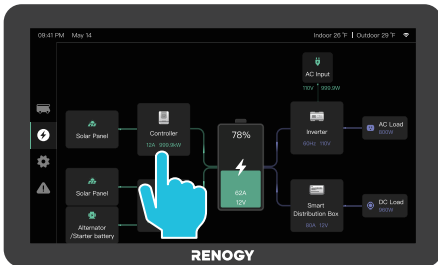

7.3. Settings

In the Settings interface, you can configure the following information:



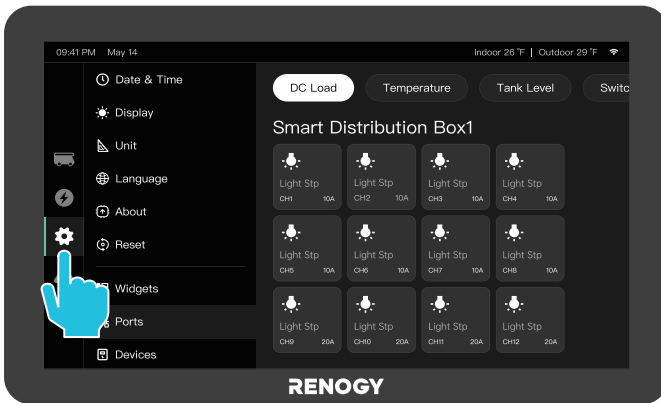

- WLAN
- Personal Hotspot
- Date & Time
- Display: display dimming time and screensaver mode. To exit screensaver mode, tap the display of ONE Vision.
- Unit: temperature and water level units
- Language: display language
- About: Renogy ONE Vision info
- Reset: Reset Renogy ONE Vision to factory mode.
- Widgets: smart scene and device widget settings
- Ports: DC load, temperature sensor, water level sensor, intelligent ONE Vision port, touch screen switch, remote inverter switch, and nominal battery capacity and SOC synchronization switch
- Devices: power supply devices, such as Battery Shunt 300A

Tap a module in the menu to enter Editing Mode.



7.4. Alarm & Troubleshooting

The Alarm & Troubleshooting interface displays system alarms and relative troubleshooting tips. Renogy ONE Vision provides several types of alarms:

Icon	Alarm
	Level III Alarm. Critical alarms that need to be addressed immediately. Otherwise, device damage or human injury may occur.
	Level II Alarm: Severe alarms
	Level I Alarm: Medium-level alarms
	Level 0 Alarm: Low-level alarms

Tap an alarm to view the relative troubleshooting solutions. An alarm automatically disappears from the interface once the issue is solved.

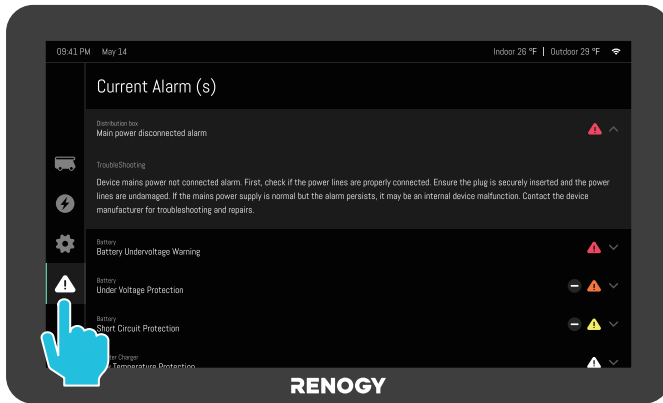

8. Dimensions & Specifications

8.1. Dimensions

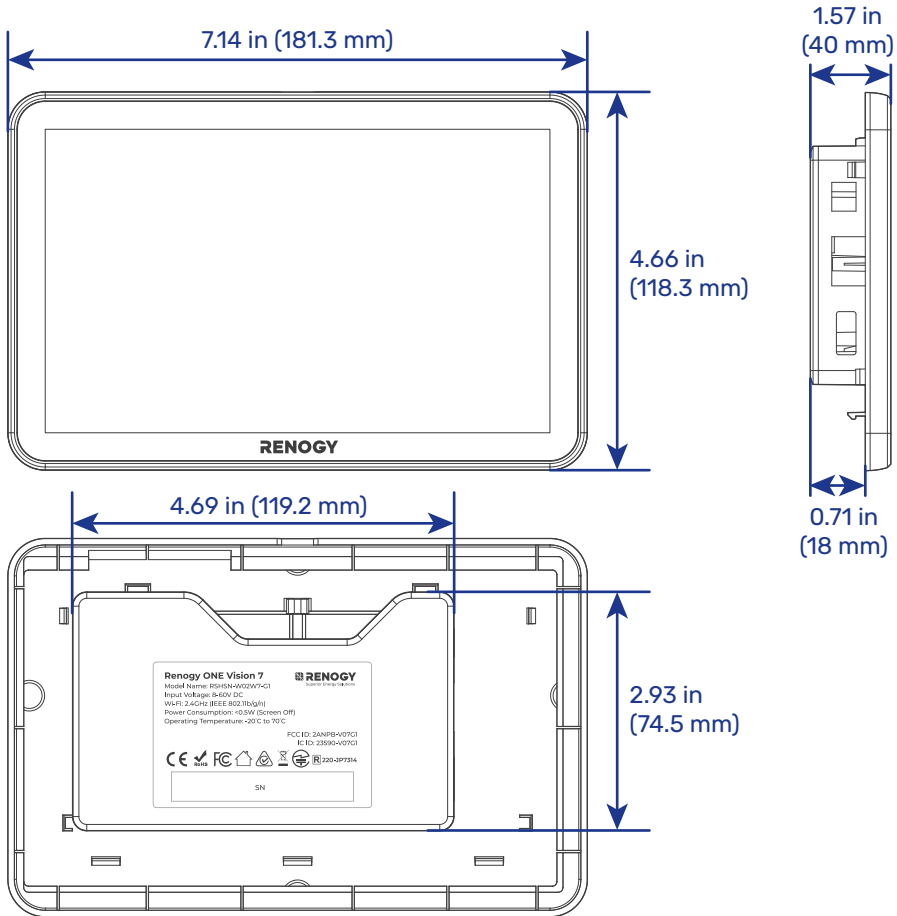

 Dimension tolerance: ± 0.2 in (0.5 mm)

8.2. Technical Specifications

Model Name	RSHSN-W02W7-G1
Input Voltage	8-60V DC (Typical 12V DC)
Power Consumption	0.5W @12V (Screen Off @Wi-Fi On)
Operating System	Android 12
CPU and Memory	Quad-core Cortex-A53 64-bit CPU Memory: 2GB Storage: 32GB
Display Screen	7-inch touch screen Resolution: 600 x 1024p Brightness: 300 cd/m ²
Wi-Fi	2.4 GHz Wi-Fi (IEEE 802.11b/g/n)
Bluetooth	2.4 GHz Bluetooth Low Energy
Ethernet	100Mbps
USB-A	USB flash drive for OTG
Installation	Flush mounting
Fire Rating	UL 94V-0
Dimensions	7.1 x 4.7 x 0.99 in (181.4 x 118.4 x 25.2 mm)
Weight	0.77 lb (350g)
Operating Temperature	-4°F to 158°F (-20°C to 70°C)
Storage Temperature	-22°F to 176°F (-30°C to 80°C)
Operating Humidity	10%~90% RH (non-condensing)
Operating Altitudes	Less more 5000 m (16404.2 ft)
Certifications	RCM, FCC, CE, IC, UKCA, RoHS and Reach
Warranty	2 years

9. Maintenance

9.1. Inspection

For optimum performance, it is recommended to perform these tasks regularly.

- Ensure there is no damage or wear on Renogy ONE Vision.
- Ensure Renogy ONE Vision is installed in a clean, dry, and ventilated area.
- Ensure the firmness of the connectors and check if there are any loose, damaged or burnt connections.
- Ensure there is no corrosion, insulation damage, or discoloration marks of overheating or burning.

 In some applications, corrosion may exist around the terminals. Corrosion can loosen springs and increase resistance, leading to premature connection failure. Apply dielectric grease to each terminals contact periodically. Dielectric grease repels moisture and protects the terminals contacts from corrosion.

 Risk of electric shock! Make sure that all power supplies are turned off before touching terminals on Renogy ONE Vision.

9.2. Cleaning

Follow the steps below to clean Renogy ONE Vision regularly.

- Disconnect all cables connected to Renogy ONE Vision.
- Wipe the housing and connector contacts of Renogy ONE Vision with a dry cloth or nonmetallic brush. If it is still dirty, you can use household cleaners.
- Dry Renogy ONE Vision with a clean cloth and keep the area around Renogy ONE Vision clean and dry.
- Make sure Renogy ONE Vision is completely dry before reconnecting it to relevant devices.
- Follow the installation instructions in the user manual in sequence during wiring.

9.3. Storage

Follow the tips below to ensure that Renogy ONE Vision is stored well.

- Disconnect all cables connected to Renogy ONE Vision.
- Apply dielectric grease to each terminals to repel moisture and protect the connector contacts from corrosion.
- Store Renogy ONE Vision in a well-ventilated, dry, and clean environment with the temperature at -22°F to 176°F (-30°C to 80°C).

10. Emergency Responses

In the event of any threat to health or safety, always begin with the steps below before addressing other suggestions.

- Immediately contact the fire department or other relevant emergency response team.
- Notify all people who might be affected and ensure that they can evacuate the area.

 Only perform the suggested actions below if it is safe to do so.

10.1. Fire

1. Disconnect all cables connected to Renogy ONE Vision.
2. Disconnect all cables connected to Renogy ONE Vision if feasible, ensuring your safety on the premises. Put out the fire with a fire extinguisher. Acceptable fire extinguishers include water, CO₂, and ABC dry power.

 Do not use type D (flammable metal) fire extinguishers.

10.2. Flooding

1. If Renogy ONE Vision is submerged in water, stay away from the water.
2. Disconnect all cables connected to Renogy ONE Vision.

10.3. Smell

1. Ventilate the room.
2. Disconnect all cables connected to Renogy ONE Vision.
3. Ensure there is no discoloration marks of overheating or burning.

10.4. Noise

1. Disconnect all cables connected to Renogy ONE Vision.
2. Make sure no foreign objects are stuck in Renogy ONE Vision.

11. Important Safety Information

11.1. General Safety

- Wear proper protective equipment and use insulated tools during installation and operation. Do not wear jewelry or other metal objects when working on or around the distribution box.
- Keep Renogy ONE Vision out of the reach of children.
- Do not dispose of Renogy ONE Vision as household waste. Comply with local, state, and federal laws and regulations and use recycling channels as required.
- If Renogy ONE Vision is installed improperly on a boat, it may cause damage to components of the boat. Have Renogy ONE Vision by a qualified electrician.
- Clean Renogy ONE Vision regularly.
- Do not puncture, drop, crush, penetrate, shake, strike, or step on Renogy ONE Vision.
- Always connect the negative before the positive.

11.2. ONE Vision Safety

- There are no serviceable parts in Renogy ONE Vision. Do not open, dismantle, repair, tamper with, or modify Renogy ONE Vision.
- Keep ONE Vision away from any heater.
- Do not insert foreign objects into ONE Vision.
- Confirm device polarities before wiring and connection. A reverse polarity contact can result in damage to ONE Vision and other connected devices, thus voiding the warranty.
- Disconnect all connectors from ONE Vision before maintenance or cleaning.

Renogy Support

To discuss inaccuracies or omissions in this quick guide or user manual, visit or contact us at:

[G | renogy.com/support/downloads](https://renogy.com/support/downloads)

 contentservice@renogy.com

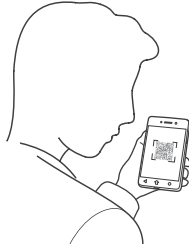

Questionnaire Investigation



To explore more possibilities of solar systems, visit Renogy Learning Center at:

[G | renogy.com/learning-center](https://renogy.com/learning-center)

For technical questions about your product in the U.S., contact the Renogy technical support team through:

[G | renogy.com/contact-us](https://renogy.com/contact-us)

 1(909)2877111

For technical support outside the U.S., visit the local website below:

[Canada | !\[\]\(1fe35e27b64f2cbe9d91692407739e94_img.jpg\) | ca.renogy.com](https://ca.renogy.com)

[China | !\[\]\(86d3b88fd0158517fb1486a387a3286e_img.jpg\) | www.renogy.cn](https://www.renogy.cn)

[Australia | !\[\]\(d0348104d649dce8ac4d39dfb5bdc990_img.jpg\) | au.renogy.com](https://au.renogy.com)

[Japan | !\[\]\(bb05bc2a221c8b0c6f74fbc79431cc72_img.jpg\) | jp.renogy.com](https://jp.renogy.com)

[South Korea | !\[\]\(279e5ca9ff6db14b931212f0d02466c7_img.jpg\) | kr.renogy.com](https://kr.renogy.com)

[Germany | !\[\]\(32e690f510c20c9b52ef5257096d66a5_img.jpg\) | de.renogy.com](https://de.renogy.com)

[United Kingdom | !\[\]\(d1558503c4af8d50d5e77a7a2317937c_img.jpg\) | uk.renogy.com](https://uk.renogy.com)

[Other Europe | !\[\]\(7ac9149c311be44e3668c36226e60d19_img.jpg\) | eu.renogy.com](https://eu.renogy.com)

FCC Statement

This device complies with Part 15 of the FCC Rules. Operation is subject to the following two conditions:

- (1) This device may not cause harmful interference, and
- (2) This device must accept any interference received, including interference that may cause undesired operation.

This equipment has been tested and found to comply with the limits for a Class B digital device, pursuant to Part 15 of the FCC Rules. These limits are designed to provide reasonable protection against harmful interference in a residential installation. This equipment generates uses and can radiate radio frequency energy and, if not installed and used in accordance with the instructions, may cause harmful interference to radio communications. However, there is no guarantee that interference will not occur in a particular installation. If this equipment does cause harmful interference to radio or television reception, which can be determined by turning the equipment off and on, the user is encouraged to try to correct the interference by one or more of the following measures:

- (1) Orient or relocate the receiving antenna.
- (2) Increase the separation between the equipment and receiver.
- (3) Connect the equipment into an outlet on a circuit different from that to which the receiver is connected.
- (4) Consult the dealer or an experienced radio/TV technician for help.

FCC Radiation Exposure Statement

This equipment complies with FCC radiation exposure limits set forth for an uncontrolled environment. This equipment should be installed and operated with minimum distance 20cm between the radiator & your body.

Industry Canada Statement

English

This device complies with Industry Canada licence-exempt RSS standard(s). Operation is subject to the following two conditions:

- (1) this device may not cause interference, and
- (2) this device must accept any interference, including interference that may cause undesired operation of the device.

French

Le présent appareil est conforme aux CNR d'Industrie Canada applicables aux appareils radio exempts de licence. L'exploitation est autorisée aux deux conditions suivantes:

- (1) l'appareil nedoit pas produire de brouillage, et
- (2) l'utilisateur de l'appareil doit accepter tout brouillage radioélectrique subi, même si le brouillage est susceptible d'en compromettre le fonctionnement.



Renogy Empowered

Renogy aims to empower people around the world through education and distribution of DIY-friendly renewable energy solutions.

We intend to be a driving force for sustainable living and energy independence.

In support of this effort, our range of solar products makes it possible for you to minimize your carbon footprint by reducing the need for grid power.



Live Sustainably with Renogy

Did you know? In a given month, a 1 kW solar energy system will...



Save 170 pounds of coal from being burned



Save 300 pounds of CO₂ from being released into the atmosphere



Save 105 gallons of water from being consumed



Renogy Power PLUS

Renogy Power Plus allows you to stay in the loop with upcoming solar energy innovations, share your experiences with your solar energy journey, and connect with like-minded people who are changing the world in the Renogy Power Plus community.



@Renogy Solar



@renogyofficial



@Renogy

Renogy reserves the right to change the contents of this manual without notice.

Manufacturer: RENOGY New Energy Co.,Ltd
Address: No.66, East Ningbo Road Room 624-625 Taicang German
Overseas Students Pioneer Park JiangSu 215000 CN



eVatmaster Consulting GmbH
Battinastr. 30
60325 Frankfurt am Main, Germany
contact@evatmaster.com

Manufacturer: RENOGY New Energy Co.,Ltd
Address: No.66, East Ningbo Road Room 624-625 Taicang German
Overseas Students Pioneer Park JiangSu 215000 CN



EVATOST CONSULTING LTD
Suite 11, First Floor, Moy Road Business
Centre, Taffs Well, Cardiff, Wales, CF15 7QR
contact@evatmaster.com



FCC ID: 2ANPB-V07G1

IC ID: 23590-V07G1